

## Guide System for CAMLOG® and CONELOG® PROGRESSIVE-LINE Implants

a perfect fit

camlog

# Clinical application examples - planning and surgery with PROGRESSIVE-LINE Guide

## Immediate restoration in an edentulous maxilla

Dr. Jan Spieckermann, Chemnitz



Baseline clinical findings on the day of initial presentation. The periodontally damaged teeth 15, 25 and 27 are clinically mobile and not worth preserving. To be able to offer the patient an optimal and safe solution, guided implant insertion was preferred. To stabilize the planned SMOP template, the teeth were left in place until implant insertion.

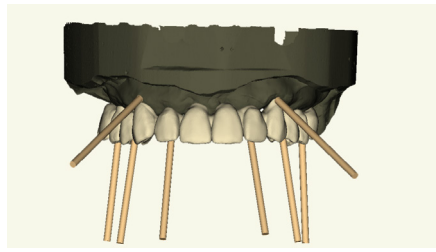

To define the surgically and prosthetically optimal implant positions, the osseous situation in the form of DICOM data, the STL data of the clinical situation and the virtual tooth set-up served as the basis. Implants under still existing incorporated metal constructions can be planned reliably with imaging techniques.



After checking the esthetics and function of the printed wax-up, the position and axial direction of the implants were defined by virtual articulation of the scanned models and by matching with the X-ray data on the one hand. On the other, the accompanying necessary surgical measures were pre-planned.

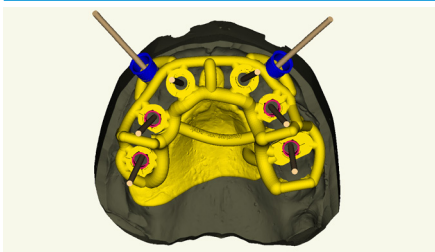

For minimally invasive guided implant placement, the drilling template was constructed in a "spaghetti design". The natural teeth in region 15, 25 and 27 and two anchor pins in the anterior tooth region were used for the exact positioning of the template. These additionally secure the template against tilting. The pontic in region 26 was removed prior to surgery.



Simultaneously with the 3D printing of the template for guided surgery, a milling order for the long-term temporary restoration was placed with a milling center. For intraoral bonding of the immediate temporary restoration, the areas to accommodate the titanium caps were recessed.



The template, which was anchored tilt-resistant via pins, enabled the precise transfer of the implant position to the clinical situation. The guide sleeves of the template were used for implant bed preparation and insertion of the implants. Here, the focus should be placed on the insertion depth and alignment of the inner geometry of the implant.



For minimally invasive implant surgery, the jawbone was first exposed using a gingiva punch. Preparation of the implant sites followed in accordance with the surgical protocol. An external sinus lift was performed in region 16 and an internal sinus lift in region 26 with the implant (Geistlich Bio-Oss® bone substitute material).

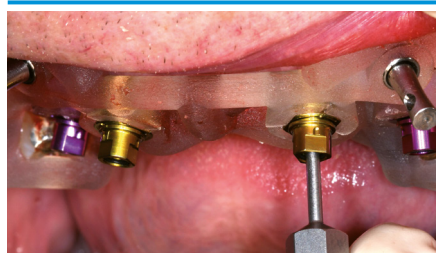

The PROGRESSIVE-LINE implants with screw-retained insertion posts were inserted to the exact stop on the sleeves. Alignment of the inner configuration is realized via the markings. Positioning of the CAMLOG® groove is important to ensure the planned common insertion direction when using angled abutments.

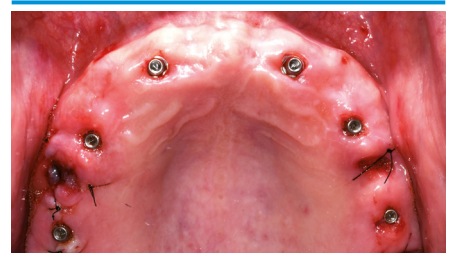

In this case, straight COMFOUR® Abutments were screw-retained in the primary stable anchored implants following implant insertion. This was followed by extraction of the non-sustainable teeth and suture closure of the extraction sockets in the area of the external sinus lift 16.

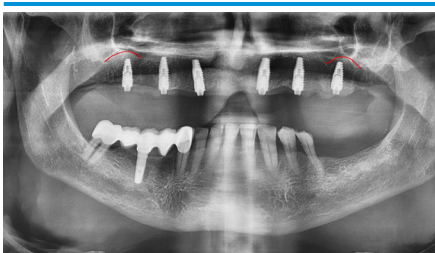

Intraoperatively, the implants demonstrated very good primary stability, and the postoperative control image revealed correct implant positions (sinus lift at 16, 26). One can clearly observe the external geometry with its progressive, projecting thread design as well as the already inserted COMFOUR® Abutments.

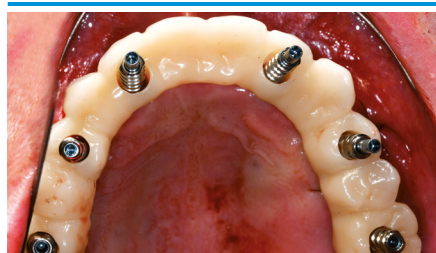

The titanium caps screw-retained onto the bar abutments were polymerized. The high titanium caps allow secure, dry intraoperative bonding. Precise planning and surgical implementation were reflected by the fact that the bonded areas did not require reworking. After finishing and polishing, the temporary restoration was incorporated on the day of surgery.



At removal of the sutures after one week, the gingival conditions were free of irritation with the onset of papillae and pontic formation. The punctures of the fixation pins are still visible apically 13, 23. After osseointegration of the implants, the definitive prosthetic restoration is to follow four months later.

## Guided immediate implantation and immediate restoration - a state-of-the-art treatment concept

Dr. Sven-Marcus Beschnidt, Baden-Baden

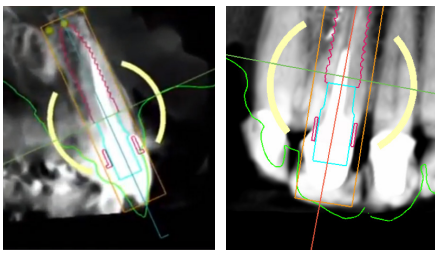

Initial findings and digital planning: following a subgingival root fracture, a temporary restoration was performed with a root post and reattachment of the crown. The long-term prosthetic prognosis of the tooth was questionable to poor. Immediate implantation was planned on the basis of digital imaging and 3D diagnostics.

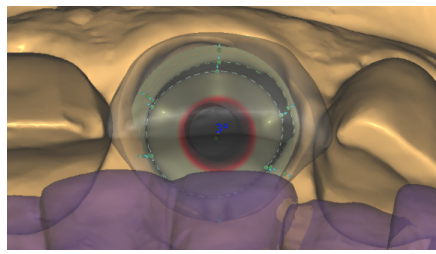

After merging the DVT and DICOM data, the optimal prosthetically oriented position of the implant was determined. The abutment was then designed completely digitally. The focus here was on the exact copy of the anatomical tooth shape of the adjacent tooth, from which the design of the crown emergence profile could be deduced.

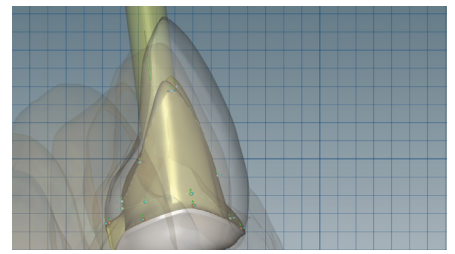

To achieve stable peri-implant soft tissue, the treatment concept provides for the insertion of a definitive hybrid abutment made of zirconia, bonded to a titanium base CAD/CAM. In addition to the provisional crown, the definitive zirconia cap was fabricated pre-operatively to avoid any loosening of the abutment from the biological structure.



Due to the deep subcrestal positioning of the implant and to avoid injuring the thin vestibular bone structures during insertion, the titanium bonding base had to be modified in this case. The zirconia abutment was bonded extraorally. The temporary resin crown is attached to the abutment without cement using the integrated snap-on.



A drilling template with the PROGRESSIVE-LINE Guide sleeve was used for optimal preparation of the implant site following tooth extraction. Guidance of the drills in the sleeves prevents deflection of the rotary surgical instruments and enables precise positioning of the implant.



The root remnant was extracted with maximum preservation of the surrounding tissue. Special attention was paid to preserving the extremely thin facial lamella. For this reason, the root was fragmented and the individual segments removed. Prior to drilling, the granulated tissue was removed from the bone compartment.

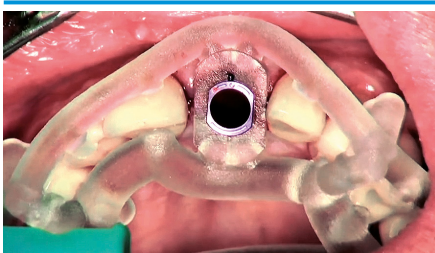

When inserting the drilling template, its fit was first checked. Support was designed to secure the template against rotation during the procedure. Depth drilling was performed step by step according to the protocol. The drill hole was prepared undersized for the soft bone in the upper jaw.



The decision for underpreparation of the  $\varnothing$  4.3 mm implant site was made prior to surgery. The PROGRESSIVE-LINE Guide  $\varnothing$  3.8 mm form drills are used for this purpose. As a result, primary stability can be predictably achieved in the extraction socket, where only the lower third of the implant body engages with the bone.

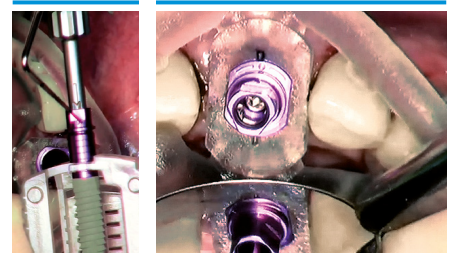

A CONELOG® PROGRESSIVE-LINE Implant ( $\varnothing$  4.3 mm / L 16 mm) was inserted. The screw-retained implant version is to be used for guided surgery. To achieve correct alignment of the inner configuration, appropriate correlating markings are provided on both the insertion post as well as the insertion instrument and the sleeve.

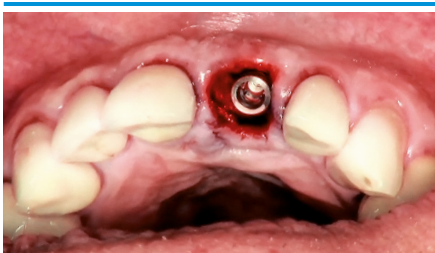

The implant was placed approximately 1.5 mm below the alveolar bone margin. The interdental bone peaks were preserved. Bone substitute material was placed in the gap between the implant and the bone to support the facial bone lamella.



Following bone augmentation, an acellular dermal matrix (NovoMatrix®/BioHorizons) was placed to thicken the soft tissue and fixed with sutures. The surgical site was sealed with the hybrid abutment, which was screw-retained in the implant at 20 Ncm.

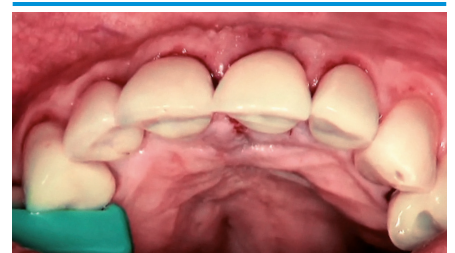

The temporary resin crown, which had been created via the CAD/CAM process, could be inserted after minimal functional corrections. The temporary restoration had no contact in static and dynamic occlusion on purpose to positively influence healing of the implant.

# The Guide System for CAMLOG® and CONELOG® PROGRESSIVE-LINE Implants

Guided implant surgery is considered to be a safe, minimally invasive procedure. This supports patient-friendly treatment concepts such as immediate implantations and immediate restorations. Drilling templates, which are created based on optically recorded data and preoperative 3D implant planning in the context of backward planning, enable precisely positioned preparation of the implant bed as well as correct three-dimensional insertion of the implant, taking into account anatomically critical structures. Various software solutions are available for the workflow and, in the case of the PROGRESSIVE-LINE Guide System, also the hardware.

The Guide System for PROGRESSIVE-LINE is based on the current guide solution of SCREW-LINE Implants established in the market - however with several updates, such as the multi-patient drills, Ø 5.0 mm implants, the option of underpreparation for Ø 3.8 and 4.3 mm implants and new guide sleeves which are not compatible with the SCREW-LINE. The Guide System surgery tray CAMLOG®/CONELOG® PROGRESSIVE-LINE is available for the new multi-patient drills.

All PROGRESSIVE-LINE Implants with screw-retained insertion posts are "guide-compatible". The screw-retained insertion posts are color-coded according to their diameters and provided with grooves for determining the gingival heights.

## The features at a glance

- All drills are multi-patient drills - can be used with external cooling
- Option for underpreparation of the implant bed for the Ø 3.8 and 4.3 mm implants
- Customizable surgery set
- Pre-drill, form drill and dense bone drill with laser-marked dark drill tips
- Guide sleeves matched to the dimensions of the insertion posts
- Flexible drilling protocols to achieve targeted primary stability of PROGRESSIVE-LINE Implants in different bone qualities

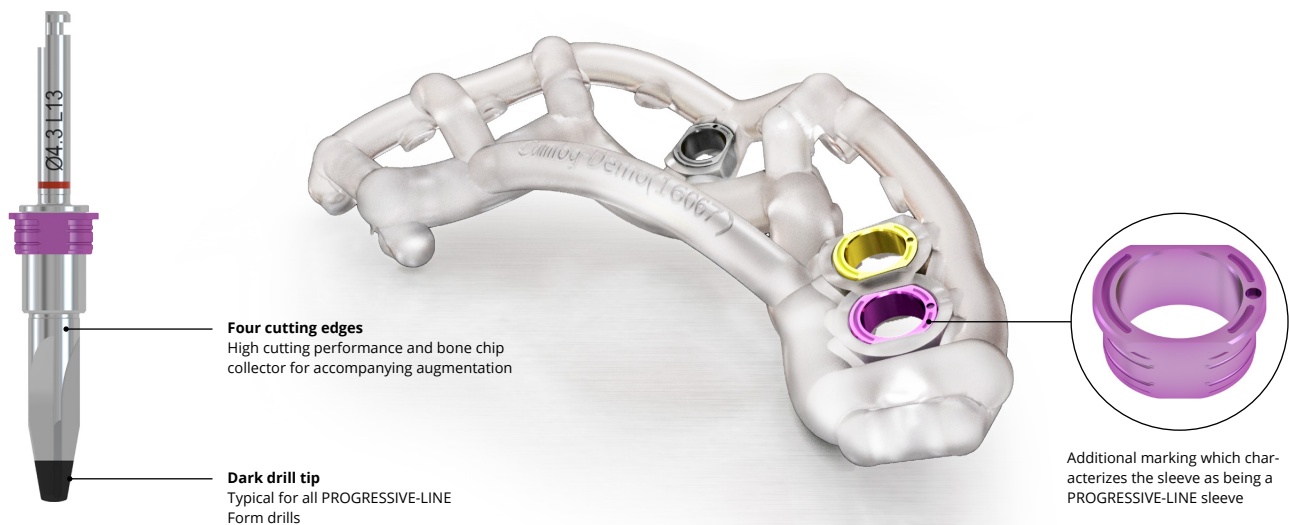

## PROGRESSIVE-LINE Implants

The innovative design of the PROGRESSIVE-LINE Implants has convinced many users since its market launch in 2019. The implants with the well-known CAMLOG® and CONELOG® inner configurations are consistently designed to achieve high primary stability even in very soft bone or in extraction sockets.<sup>1,2</sup> To make procedures more efficient and to enable patient-friendly immediate treatment concepts, the implants offer design features such as an apically conical implant body, a progressive projecting thread design and a crestal anchoring thread.

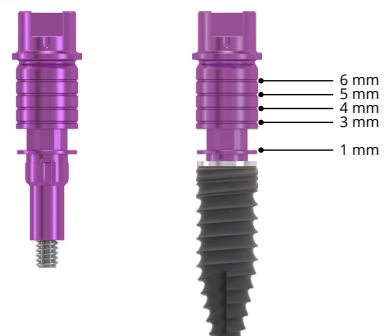

<sup>1</sup> Conserva E. Initial stability after placement of a new buttress threaded implant. A case series study. *implants*. 2019(3):24-28.

<sup>2</sup> Rupp J. One-year clinical experience with Progressive-Line implants. *EDI Journal*. 2020(4):54-63.

# A Surgery Set CAMLOG® / CONELOG® PROGRESSIVE-LINE Guide

PROGRESSIVE-LINE Implants are available as CONELOG® PROGRESSIVE-LINE and as CAMLOG® PROGRESSIVE-LINE in diameters 3.3, 3.8, 4.3 and 5.0 mm as well as in lengths 7 (CONELOG® only), 9, 11, 13 and 16 mm. For Guide Surgery, it is essential to use PROGRESSIVE-LINE Implants with screw-retained insertion posts.

The drills for the PROGRESSIVE-LINE Guide System are multi-patient drills to be used with external cooling. Like all PROGRESSIVE-LINE Drills, they feature a laser-marked dark drill tip.

A surgery tray is available for storing the drills and instruments. The tray, same as the drills, is color-coded according to the implant diameters. It is supplied empty and can be customized according to the preferences of the clinician. Additional drills required for the underpreparation of the Ø 3.8 mm implants can be stored in the tray on the bottom right.



Surgery tray CAMLOG®/CONELOG® PROGRESSIVE-LINE Guide fully equipped (the tray is supplied without instruments and drills)



## The dense bone drill PROGRESSIVE-LINE Guide – Reduced Insertion Torque in Hard Bone

In hard bone, the dense bone drill reduces the insertion torque. This is just as easy to use as an ordinary form drill.

### User benefits

- Same drill speed as form drills (depending on diameter)
- No searching for the pre-cut thread



# Flexible drilling protocols - for targeted primary stability

The PROGRESSIVE-LINE implant demonstrates its strengths particularly in soft bone - without additional treatment steps (e.g. the use of osteotomes). The drilling protocol is extremely flexible and can be adapted to the respective clinical situation. Depending on the available bone quality, a decision for the respective protocol can be made intraoperatively. For example, underpreparation of the implant bed can be performed if the bone is predominantly cancellous.

Users of PROGRESSIVE-LINE Implants appreciate this freedom of choice. Therefore, these options have also been integrated into the PROGRESSIVE-LINE Guide System and can be realized with implant diameters of 3.8 and 4.3 mm.

## Drilling protocol

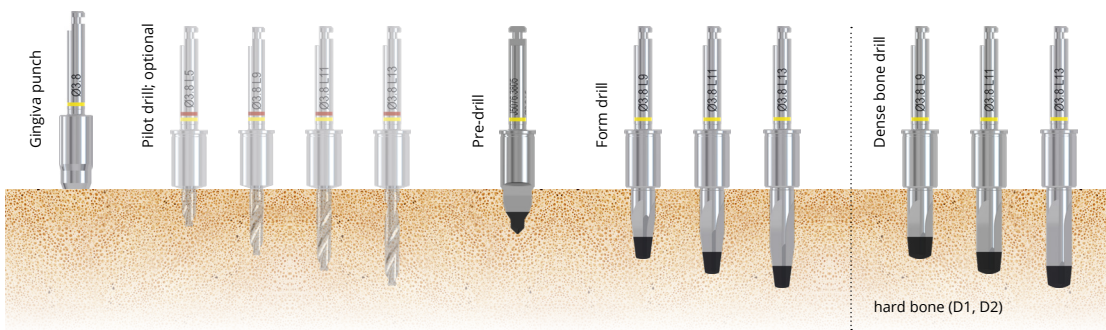

Exemplary representation of a Ø 3.8 mm / L 13 mm PROGRESSIVE-LINE Implant.

## Drilling protocol in very soft bone: underpreparation

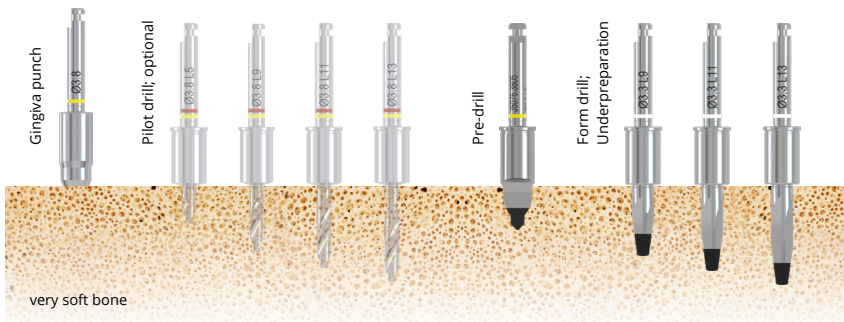

Exemplary representation of a Ø 3.8 mm / L 13 mm PROGRESSIVE-LINE Implant.

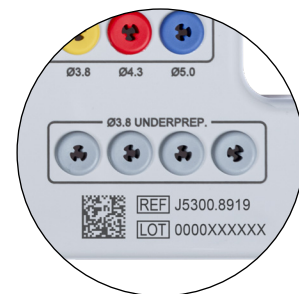

Form drill;  
Underpreparation  
Surgery tray

Underpreparations are possible with the PROGRESSIVE-LINE Guide System in implant diameters of 3.8 and 4.3 mm. Specially designed drills are additionally required for the Ø 3.8 mm to provide precise guidance in correlation with the guide sleeves. These can be stored in the surgery tray on the bottom right. The form drills for underpreparation feature an additional marking on the shaft (FD/U-P).

The Ø 3.8 mm form drills are used for the underpreparation of the Ø 4.3 mm PROGRESSIVE-LINE Implants. The dimensions of the insertion posts as well as the guide sleeves for both implant diameters are identical.



# The drilling template and its fabrication - efficient pre-surgical procedures

Drilling templates can be fabricated conventionally or digitally - both with the aim of achieving the optimum prosthetically oriented implant position during the surgical procedure, taking into account anatomically sensitive structures. By applying modern imaging technologies and digitization, pre-surgical workflows in dental practices and laboratories have become more and more efficient, faster and reproducible.

The majority of currently fabricated drilling templates are designed on the basis of DVT or CT data sets with an implant planning system. Manufacturing is performed either manually or digitally in the laboratory or by a service partner using the 3D printing process. For example, this allows templates to be precisely realized in the context of backward planning even without cast fabrication via an additive manufacturing process.

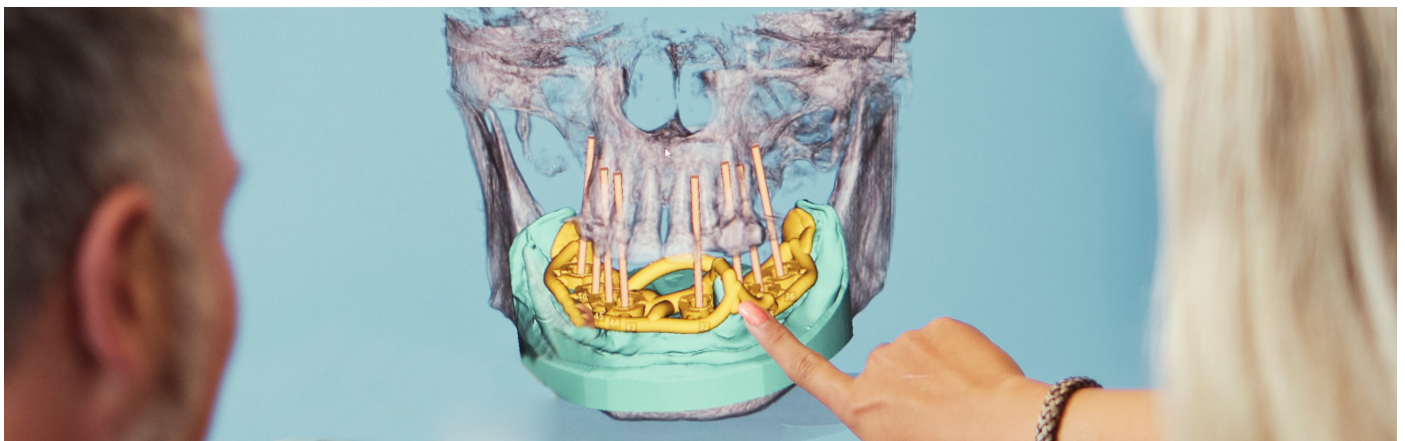
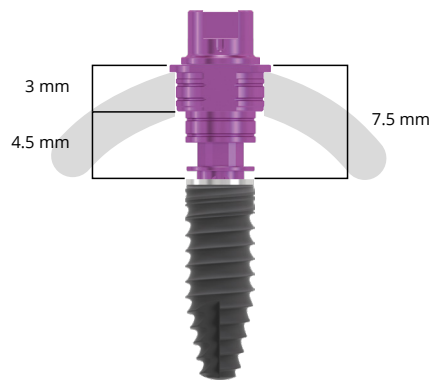

#### **Distributor Germany**

CAMLOG Vertriebs GmbH | Maybachstr. 5 | 71299 Wimsheim | Germany  
Telephone +49 7044 9445-100 | Fax +49 800 9445-000 | info.de@camlog.com | www.camlog.de  
eshop.camlog.de

#### **Distributor Austria**

Alltec Dental GmbH | Schwefel 93 | 6850 Dornbirn | Austria  
Telephone +43 5572 372341 | Fax +43 5572 372341-404 | info@alltecdental.at | www.alltecdental.at  
eshop.alltecdental.at

#### **Distributor Switzerland**

CAMLOG Biotechnologies GmbH | Margarethenstr. 38 | 4053 Basle | Switzerland  
Telephone +41 61 565 41 41 | Fax +41 61 565 41 42 | sales.ch@camlog.com | www.camlog.ch  
eshop.camlog.ch

#### **Headquarters**

CAMLOG Biotechnologies GmbH | Margarethenstr. 38 | 4053 Basle | Switzerland  
Telephone +41 61 565 41 00 | Fax +41 61 565 41 01 | info@camlog.com | www.biohorizonscamlog.com

Manufacturer CAMLOG® and CONELOG® Products: ALTATEC GmbH | Maybachstr. 5 | 71299 Wimsheim | Germany  
NovoMatrix® is manufactured by LifeCell™ Corporation, a subsidiary of Allergan.  
CAMLOG®, CONELOG®, DEDICAM® and COMFOUR® are registered trademarks of CAMLOG Biotechnologies GmbH.  
NovoMatrix® is a registered trademark of BioHorizons. Geistlich Bio-Oss® is a registered trademark of Geistlich Pharma AG.  
They may, however, not be registered in all markets.